

### FEATURES

- TIA/EIA RS-485/RS-422 compliant
- ESD protection on RS-485 I/O pins
- $\pm 15$  kV human body model (HBM)
- Data rates
  - ADM487E: 250 kbps
  - ADM485E/ADM1487E: 2.5 Mbps
- Half-duplex
- Reduced slew rates for low EMI
- Common-mode input range:  $-7$  V to  $+12$  V
- Thermal shutdown and short-circuit protection
- 8-lead SOIC packages
- ADM487EW qualified for automotive applications

### APPLICATIONS

- Energy/power metering
- Lighting systems
- Industrial control
- Telecommunications
- Security systems
- Instrumentation

### GENERAL DESCRIPTION

The ADM485E/ADM487E/ADM1487E are 5 V, low power data transceivers with  $\pm 15$  kV ESD protection suitable for half-duplex communication on multipoint bus transmission lines. They are designed for balanced data transmission and comply with Telecommunication Industry Association/Electronics Industries Association (TIA/EIA) standards RS-485 and RS-422. The ADM487E and ADM1487E have a 1/4 unit load receiver input impedance that allows up to 128 transceivers on a bus, whereas the ADM485E allows up to 32 transceivers on a bus. Because only one driver is enabled at any time, the output of a disabled or power-down driver is three-stated to avoid overloading the bus.

### FUNCTIONAL BLOCK DIAGRAM

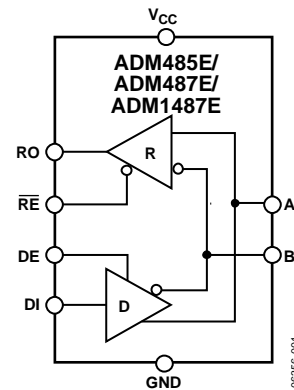

Figure 1.

The driver outputs are slew rate limited to reduce EMI and data errors caused by reflections from improperly terminated buses. Excessive power dissipation caused by bus contention or output shorting is prevented with a thermal shutdown circuit.

The parts are fully specified over the industrial temperature ranges and are available in 8-lead SOIC packages.

Table 1. Selection Table

Part Number	Half-/Full-Duplex	Guaranteed Data Rate (Mbps)	Slew Rate Limited	Low Power Shutdown	Driver/Receiver Enable	Quiescent Current ( $\mu$ A)	Number of Nodes on Bus	Pin Count
ADM485E	Half	2.5	No	No	Yes	300	32	8
ADM487E	Half	0.25	Yes	Yes	Yes	120	128	8
ADM1487E	Half	2.5	No	No	Yes	230	128	8

#### Rev. B

Information furnished by Analog Devices is believed to be accurate and reliable. However, no responsibility is assumed by Analog Devices for its use, nor for any infringements of patents or other rights of third parties that may result from its use. Specifications subject to change without notice. No license is granted by implication or otherwise under any patent or patent rights of Analog Devices. Trademarks and registered trademarks are the property of their respective owners.

## TABLE OF CONTENTS

Features .....	1	Typical Performance Characteristics .....	8
Applications.....	1	Test Circuits and Switching Characteristics.....	11
Functional Block Diagram .....	1	Theory of Operation .....	13
General Description .....	1	Circuit Description .....	13
Revision History .....	2	Applications Information .....	15
Specifications.....	3	Differential Data Transmission .....	15
Timing Specifications .....	4	Cable and Data Rate.....	15
Absolute Maximum Ratings.....	6	Outline Dimensions .....	16
ESD Caution.....	6	Ordering Guide .....	16
Pin Configuration and Function Descriptions.....	7	Automotive Products.....	16

## REVISION HISTORY

### 10/10—Rev. A to Rev. B

Added ADM487EW Qualified for Automotive Applications to Features Section .....	1
Updated Outline Dimensions .....	16
Changes to Ordering Guide .....	16
Added Automotive Products Section .....	16

### 3/08—Rev. 0 to Rev. A

Changes to Supply Voltage Range .....	Universal
Added Endnote 1 .....	3
Changes to Table 3.....	4
Changes to Table 4.....	5
Changes to Figure 12.....	9
Changes to Figure 27 and Table 9.....	14
Changes to Figure 29.....	15
Updated Outline Dimensions .....	16

### 1/07—Revision 0: Initial Version

## SPECIFICATIONS

$V_{CC} = 5\text{ V} \pm 10\%$ ,  $T_A = T_{MIN}$  to  $T_{MAX}$ , unless otherwise noted.

**Table 2. ADM485E/ADM487E/ADM1487E**

Parameter	Symbol	Min	Typ	Max	Unit	Test Conditions/Comments
<b>DRIVER</b>						
Differential Outputs						
Differential Output Voltage (No Load)	$V_{OD1}$		5		V	
Differential Output Voltage (with Load)	$V_{OD2}$	2		5	V	$R_L = 50\ \Omega$ (RS-422)
$\Delta  V_{OD} $ for Complementary Output States		1.5		0.2	V	$R_L = 27\ \Omega$ (RS-485) (see Figure 18)
Common-Mode Output Voltage	$V_{OC}$			3	V	$R_L = 27\ \Omega$ or $50\ \Omega$ (see Figure 18)
$\Delta  V_{OC} $ for Complementary Output States				0.2	V	$R_L = 27\ \Omega$ or $50\ \Omega$ (see Figure 18)
Logic Inputs						
Input High Voltage	$V_{IH}$	2.0			V	DE, DI, $\overline{RE}$
Input Low Voltage	$V_{IL}$			0.8	V	DE, DI, $\overline{RE}$
Logic Input Current <sup>1</sup>	$I_{IN1}$			$\pm 2$	$\mu\text{A}$	DE, DI, $\overline{RE}$
<b>RECEIVER</b>						
Input Current (A, B)	$I_{IN2}$			1.0	mA	DE = 0 V, $V_{IN} = 12\text{ V}$
		-0.8			mA	$V_{CC} = 0\text{ V}$ or $5.25\text{ V}$ , $V_{IN} = -7\text{ V}$ (ADM485E)
				0.25	mA	DE = 0 V, $V_{IN} = 12\text{ V}$
		-0.2			mA	$V_{CC} = 0\text{ V}$ or $5.25\text{ V}$ , $V_{IN} = -7\text{ V}$ (ADM487E/ADM1487E)
Differential Inputs						
Differential Input Threshold Voltage	$V_{TH}$	-0.2		+0.2	V	$-7\text{ V} < V_{CM} < +12\text{ V}$
Input Hysteresis	$\Delta V_{TH}$		70		mV	$V_{CM} = 0\text{ V}$
Receiver Output Logic						
Output Voltage High	$V_{OH}$	3.5			V	$I_{OUT} = -4\text{ mA}$ , $V_{ID} = +200\text{ mV}$
Output Voltage Low	$V_{OL}$			0.4	V	$I_{OUT} = +4\text{ mA}$ , $V_{ID} = -200\text{ mV}$
Three-State Output Leakage Current	$I_{OZR}$			$\pm 1$	$\mu\text{A}$	$0.4\text{ V} < V_O < 2.4\text{ V}$
Receiver Input Resistance	$R_{IN}$	12			k $\Omega$	$-7\text{ V} < V_{CM} < +12\text{ V}$ (ADM485E)
		48			k $\Omega$	$-7\text{ V} < V_{CM} < +12\text{ V}$ (ADM487E/ADM1487E)
<b>POWER SUPPLY</b>						
No Load Supply Current	$I_{CC}$		500	900	$\mu\text{A}$	$\overline{RE} = 0\text{ V}$ or $V_{CC}$ , DE = $V_{CC}$ (ADM485E)
			300	500	$\mu\text{A}$	$\overline{RE} = 0\text{ V}$ or $V_{CC}$ , DE = 0 V (ADM485E)
			300	500	$\mu\text{A}$	$\overline{RE} = 0\text{ V}$ or $V_{CC}$ , DE = $V_{CC}$ (ADM1487E)
			230	400	$\mu\text{A}$	$\overline{RE} = 0\text{ V}$ or $V_{CC}$ , DE = 0 V (ADM1487E)
			250	400	$\mu\text{A}$	$\overline{RE} = 0\text{ V}$ or $V_{CC}$ , DE = $V_{CC}$ (ADM487E)
			120	250	$\mu\text{A}$	$\overline{RE} = 0\text{ V}$ , DE = 0 V (ADM487E)
Supply Current in Shutdown	$I_{SHDN}$		0.5	10	$\mu\text{A}$	DE = 0 V, $\overline{RE} = V_{CC}$ (ADM487E)
Driver Short-Circuit Current, $V_O$ High	$I_{OSD1}$	35		250	mA	$-7\text{ V} \leq V_O \leq +12\text{ V}$ , applies to peak current
Driver Short-Circuit Current, $V_O$ Low	$I_{OSD2}$	35		250	mA	$-7\text{ V} \leq V_O \leq +12\text{ V}$ , applies to peak current
Receiver Short-Circuit Current	$I_{OSR}$	7		95	mA	$0\text{ V} \leq V_O \leq V_{CC}$
<b>ESD PROTECTION</b>						
A, B			$\pm 15$		kV	Human body model

<sup>1</sup> Supply voltage is  $5\text{ V} \pm 5\%$ .

# ADM485E/ADM487E/ADM1487E

## TIMING SPECIFICATIONS

$V_{CC} = 5\text{ V} \pm 10\%$ ,  $T_A = T_{MIN}$  to  $T_{MAX}$ , unless otherwise noted.

Table 3. ADM485E/ADM1487E

Parameter	Symbol	Min	Typ	Max	Unit	Test Conditions/Comments
<b>DRIVER</b>						
Driver Propagation Delay Input to Output, Low to High	$t_{DPLH}$	10	40	60	ns	$R_{DIFF} = 54\ \Omega$ , $C_{L1} = C_{L2} = 100\text{ pF}$ (see Figure 19 and Figure 20)
Driver Propagation Delay Input to Output, High to Low	$t_{DPHL}$	10	40	60	ns	$R_{DIFF} = 54\ \Omega$ , $C_{L1} = C_{L2} = 100\text{ pF}$ (see Figure 19 and Figure 20)
Output Skew to Output	$t_{SKEW}$		5	10	ns	$R_{DIFF} = 54\ \Omega$ , $C_{L1} = C_{L2} = 100\text{ pF}$ (see Figure 19 and Figure 20)
Rise/Fall Time	$t_{DR}, t_{DF}$	3	20	40	ns	$R_{DIFF} = 54\ \Omega$ , $C_{L1} = C_{L2} = 100\text{ pF}$ (see Figure 19 and Figure 20)
Enable Time to High Level	$t_{DZH}$		45	70	ns	$C_L = 100\text{ pF}$ , S1 closed (see Figure 21)
Enable Time to Low Level	$t_{DZL}$		45	70	ns	$C_L = 100\text{ pF}$ , S1 closed (see Figure 22)
Disable Time from Low Level	$t_{DLZ}$		45	70	ns	$C_L = 15\text{ pF}$ , S1 closed (see Figure 22)
Disable Time from High Level	$t_{DHZ}$		45	70	ns	$C_L = 15\text{ pF}$ , S1 closed (see Figure 21)
<b>RECEIVER</b>						
Receiver Propagation Delay Input to Output, Low to High	$t_{RPLH}$	20	60	200	ns	See Figure 23 and Figure 24
Receiver Propagation Delay Input to Output, High to Low	$t_{RPHL}$	20	60	200	ns	See Figure 23 and Figure 24
$ t_{PLH} - t_{PHL} $ Differential Receiver Skew	$t_{SKEW}$		5		ns	See Figure 23 and Figure 24
Enable Time to Low Level	$t_{RZL}$		25	50	ns	$C_L = 15\text{ pF}$ , S2 closed (see Figure 25)
Enable Time to High Level	$t_{RZH}$		20	50	ns	$C_L = 15\text{ pF}$ , S1 closed (see Figure 25)
Disable Time from Low Level	$t_{RLZ}$		20	50	ns	$C_L = 15\text{ pF}$ , S2 closed (see Figure 25)
Disable Time from High Level	$t_{RHZ}$		20	50	ns	$t_{PLH}, t_{PHL} < 50\%$ of data period
MAXIMUM DATA RATE	$f_{MAX}$	2.5			Mbps	

$V_{CC} = 5\text{ V} \pm 10\%$ ,  $T_A = T_{MIN}$  to  $T_{MAX}$ , unless otherwise noted.

**Table 4. ADM487E**

Parameter	Symbol	Min	Typ	Max	Unit	Test Conditions/Comments
<b>DRIVER</b>						
Driver Propagation Delay Input to Output, Low to High	$t_{DPLH}$	250	800	2000	ns	$R_{DIFF} = 54\ \Omega$ , $C_{L1} = C_{L2} = 100\text{ pF}$ (see Figure 19 and Figure 20)
Driver Propagation Delay Input to Output, High to Low	$t_{DPHL}$	250	800	2000	ns	$R_{DIFF} = 54\ \Omega$ , $C_{L1} = C_{L2} = 100\text{ pF}$ (see Figure 19 and Figure 20)
Output Skew to Output	$t_{SKEW}$	250	20	800	ns	$R_{DIFF} = 54\ \Omega$ , $C_{L1} = C_{L2} = 100\text{ pF}$ (see Figure 19 and Figure 20)
Rise/Fall Time	$t_{DR}$ , $t_{DF}$	250		2000	ns	$R_{DIFF} = 54\ \Omega$ , $C_{L1} = C_{L2} = 100\text{ pF}$ (see Figure 19 and Figure 20)
Enable Time to High Level	$t_{DZH}$	250		2000	ns	$C_L = 100\text{ pF}$ , S1 closed (see Figure 21)
Enable Time to Low Level	$t_{DZL}$			2000	ns	$C_L = 100\text{ pF}$ , S1 closed (see Figure 22)
Disable Time from Low Level	$t_{DLZ}$	300		3000	ns	$C_L = 15\text{ pF}$ , S1 closed (see Figure 22)
Disable Time from High Level	$t_{DHZ}$	300		3000	ns	$C_L = 15\text{ pF}$ , S1 closed (see Figure 21)
<b>RECEIVER</b>						
Receiver Propagation Delay Input to Output, Low to High	$t_{RPLH}$	250		2000	ns	See Figure 23 and Figure 24
Receiver Propagation Delay Input to Output, High to Low	$t_{RPHL}$	250		2000	ns	See Figure 23 and Figure 24
$ t_{PLH} - t_{PHL} $ Differential Receiver Skew	$t_{SKEW}$		100		ns	See Figure 23 and Figure 24
Enable Time to Low Level	$t_{RZL}$		25	50	ns	$C_L = 15\text{ pF}$ , S2 closed (see Figure 25)
Enable Time to High Level	$t_{RZH}$		25	50	ns	$C_L = 15\text{ pF}$ , S1 closed (see Figure 25)
Disable Time from Low Level	$t_{RLZ}$		25	50	ns	$C_L = 15\text{ pF}$ , S2 closed (see Figure 25)
Disable Time from High Level	$t_{RHZ}$		25	50	ns	$t_{PLH}$ , $t_{PHL} < 50\%$ of data period
Maximum Data Rate	$f_{MAX}$	250			kbps	
Time to Shutdown <sup>1</sup>	$t_{SHDN}$	50	200	600	ns	
Driver Enable from Shutdown to Output High	$t_{DZH(SHDN)}$		5000		ns	$C_L = 100\text{ pF}$ , S1 closed (see Figure 21)
Driver Enable from Shutdown to Output Low	$t_{DZL(SHDN)}$		5000		ns	$C_L = 100\text{ pF}$ , S1 closed (see Figure 22)
Receiver Enable from Shutdown to Output High	$t_{RZH(SHDN)}$		5000		ns	$C_L = 15\text{ pF}$ , S2 closed (see Figure 25)
Receiver Enable from Shutdown to Output Low	$t_{RZL(SHDN)}$		5000		ns	$C_L = 15\text{ pF}$ , S1 closed (see Figure 25)

<sup>1</sup> The ADM487E is put into shutdown mode by bringing  $\overline{RE}$  high and DE low. If the inputs are in this state for less than 50 ns, the parts are guaranteed not to enter shutdown. If the inputs are in this state for at least 600 ns, the ADM487E is guaranteed to enter shutdown.

# ADM485E/ADM487E/ADM1487E

## ABSOLUTE MAXIMUM RATINGS

$T_A = 25^\circ\text{C}$ , unless otherwise noted.

Table 5.

Parameter	Rating
$V_{CC}$ to GND	-0.5 V to +6 V
Digital I/O Voltage (DE, $\overline{RE}$ )	-0.5 V to ( $V_{CC} + 0.5$ V)
Driver Input Voltage (DI)	-0.5 V to ( $V_{CC} + 0.5$ V)
Receiver Output Voltage (RO)	-0.5 V to ( $V_{CC} + 0.5$ V)
Driver Output/Receiver Input Voltage (A, B)	-9 V to +14 V
Operating Temperature Range	-40°C to +85°C
Storage Temperature Range	-65°C to +150°C
$\theta_{JA}$ Thermal Impedance, 8-Lead SOIC	158°C/W
Lead Temperature, Soldering (10 sec)	260°C

Stresses above those listed under Absolute Maximum Ratings may cause permanent damage to the device. This is a stress rating only; functional operation of the device at these or any other conditions above those indicated in the operational section of this specification is not implied. Exposure to absolute maximum rating conditions for extended periods may affect device reliability.

### ESD CAUTION



**ESD (electrostatic discharge) sensitive device.** Charged devices and circuit boards can discharge without detection. Although this product features patented or proprietary protection circuitry, damage may occur on devices subjected to high energy ESD. Therefore, proper ESD precautions should be taken to avoid performance degradation or loss of functionality.

## PIN CONFIGURATION AND FUNCTION DESCRIPTIONS

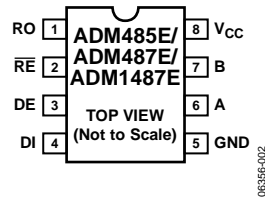

Figure 2. Pin Configuration

Table 6. Pin Function Descriptions

Pin No.	Mnemonic	Description
1	RO	Receiver Output. When enabled, if $A > B$ by 200 mV, then RO = high. If $A < B$ by 200 mV, then RO = low.
2	$\overline{RE}$	Receiver Output Enable. A low level enables the RO; a high level places it in a high impedance state.
3	DE	Driver Output Enable. A high level enables the driver differential outputs, Pin A and Pin B; a low level places the driver in a high impedance state.
4	DI	Driver Input. When the driver is enabled, a logic low on DI forces Pin A low and Pin B high; a logic high on DI forces Pin A high and Pin B low.
5	GND	Ground Connection (0 V).
6	A	Noninverting Receiver Input A/Driver Output A.
7	B	Inverting Receiver Input B/Driver Output B.
8	V <sub>CC</sub>	Power Supply (5 V ± 10%).

## TYPICAL PERFORMANCE CHARACTERISTICS

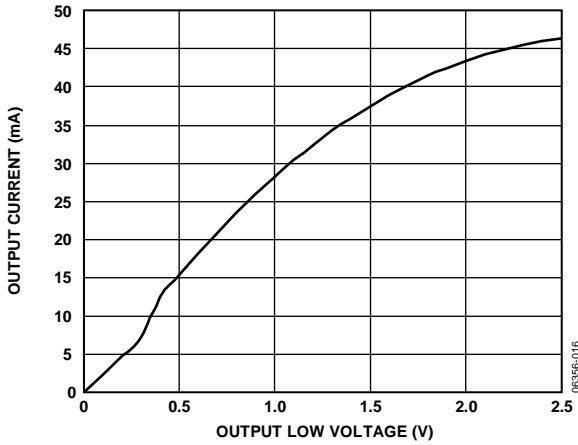

Figure 3. Output Current vs. Receiver Output Low Voltage

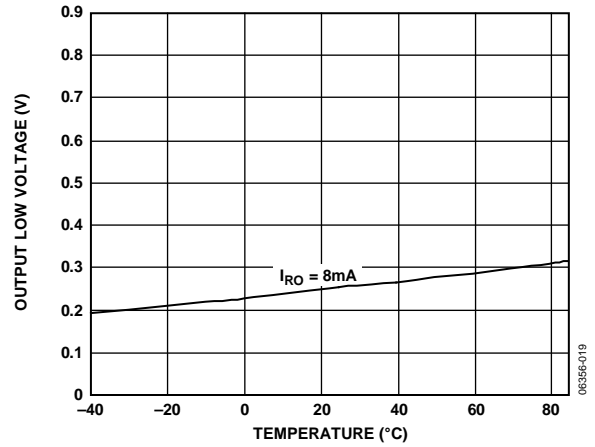

Figure 6. Receiver Output Low Voltage vs. Temperature

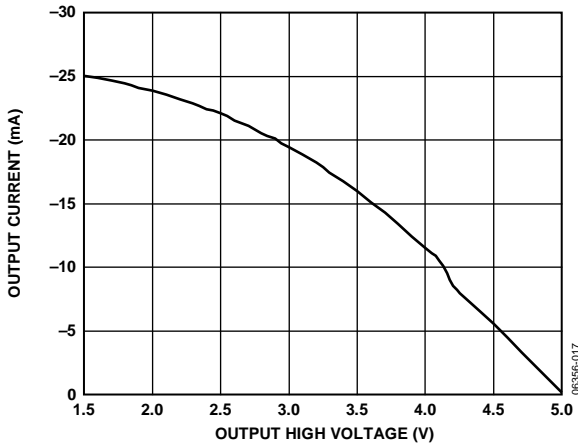

Figure 4. Output Current vs. Receiver Output High Voltage

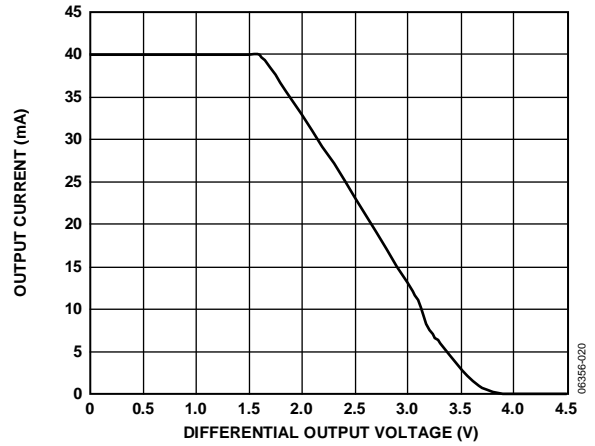

Figure 7. Driver Output Current vs. Differential Output Voltage

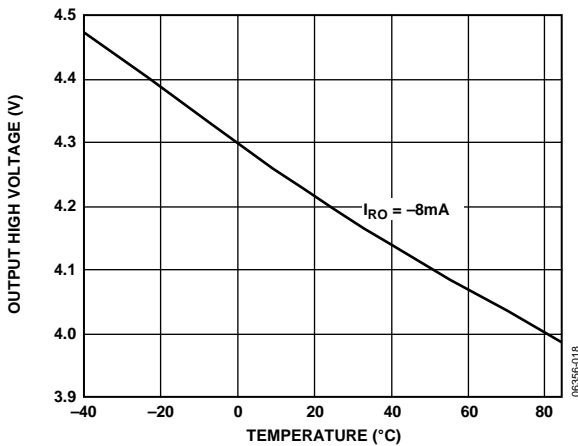

Figure 5. Receiver Output High Voltage vs. Temperature

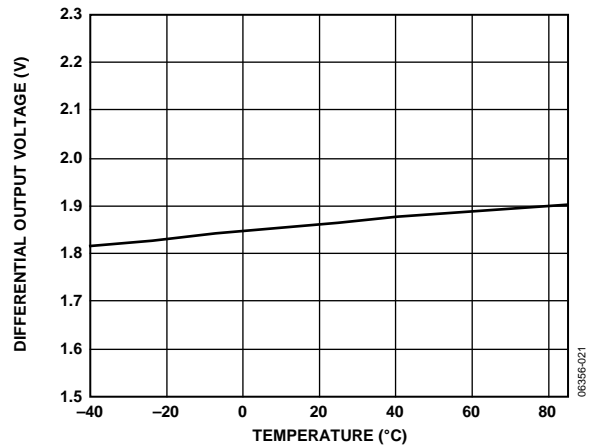

Figure 8. Driver Differential Output Voltage vs. Temperature



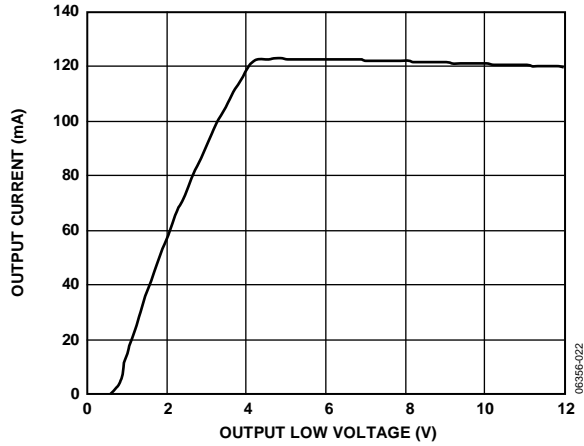

Figure 9. Output Current vs. Driver Output Low Voltage

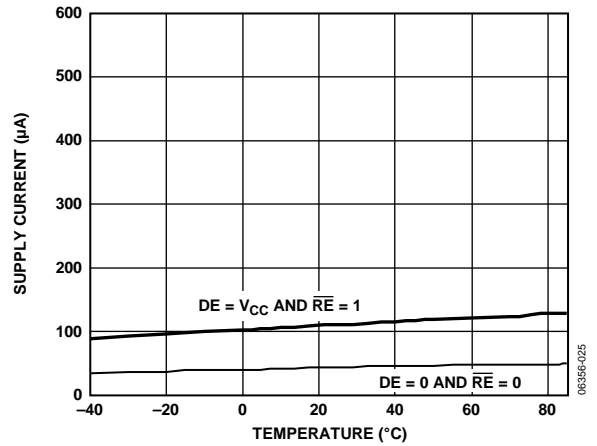

Figure 12. ADM487E Supply Current vs. Temperature

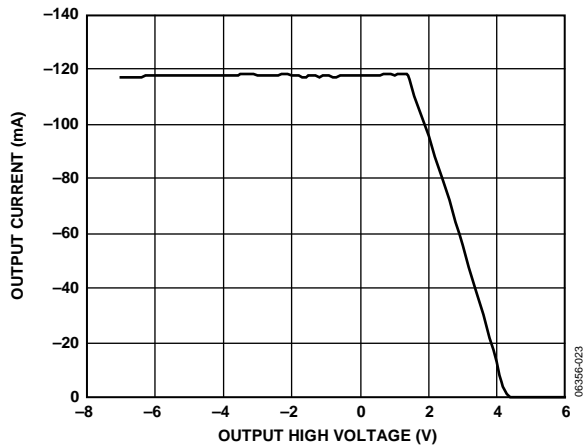

Figure 10. Output Current vs. Driver Output High Voltage

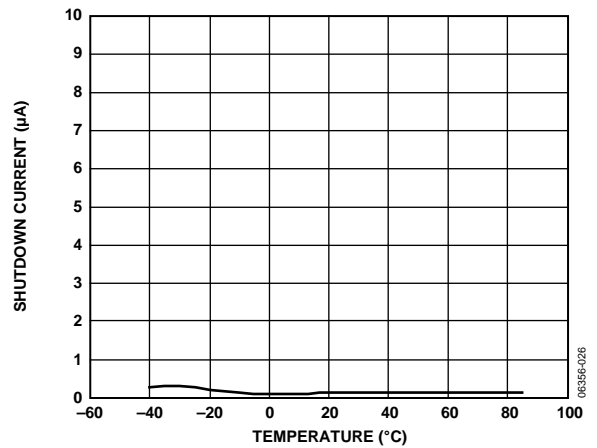

Figure 13. Shutdown Current vs. Temperature

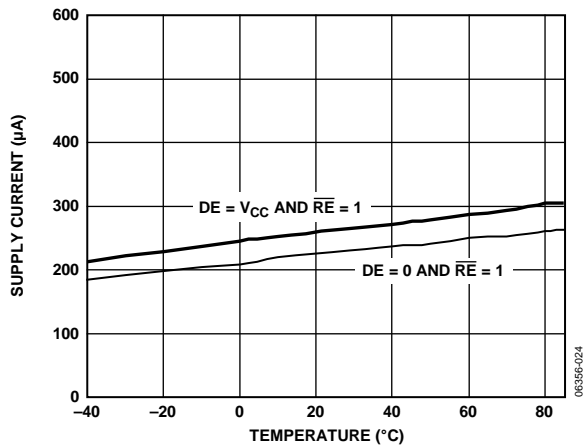

Figure 11. ADM485E/ADM1487E Supply Current vs. Temperature

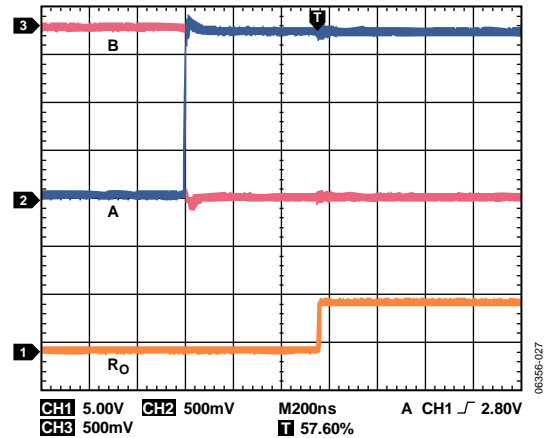

Figure 14. ADM487E Receiver  $t_{RPHL}$

# ADM485E/ADM487E/ADM1487E

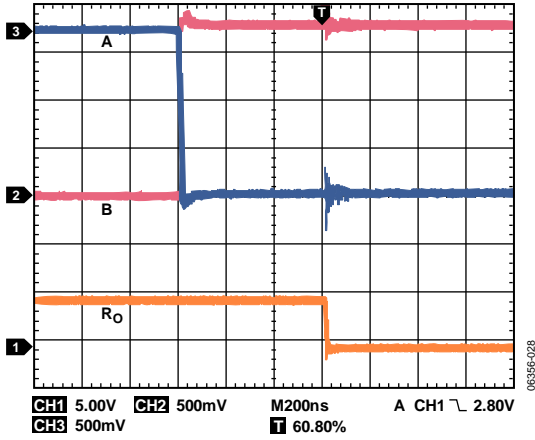

Figure 15. ADM487E Receiver  $t_{RPLH}$  Driven by External RS-485 Device

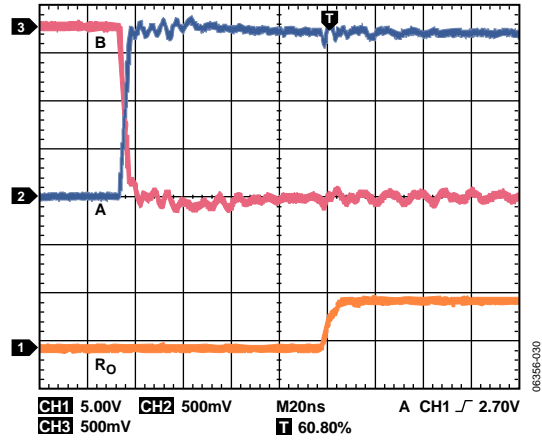

Figure 17. ADM485E/ADM1487E Receiver  $t_{RPLH}$

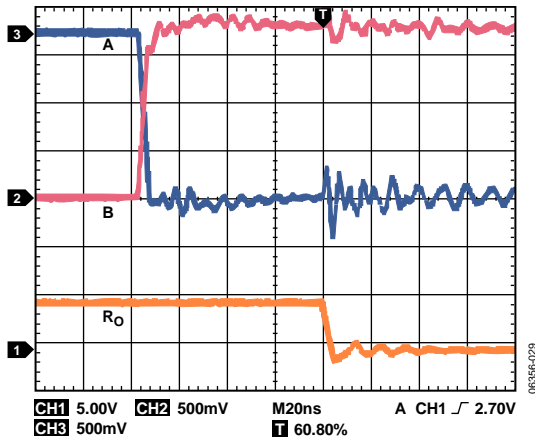

Figure 16. ADM485E/ADM1487E Receiver  $t_{RPHL}$

# TEST CIRCUITS AND SWITCHING CHARACTERISTICS

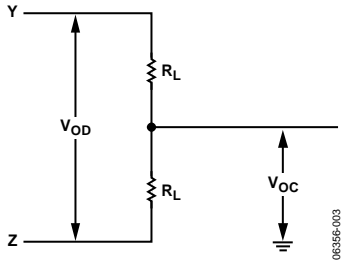

Figure 18. Driver DC Test Load

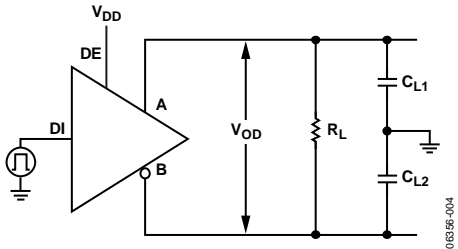

Figure 19. Driver Timing Test Circuit

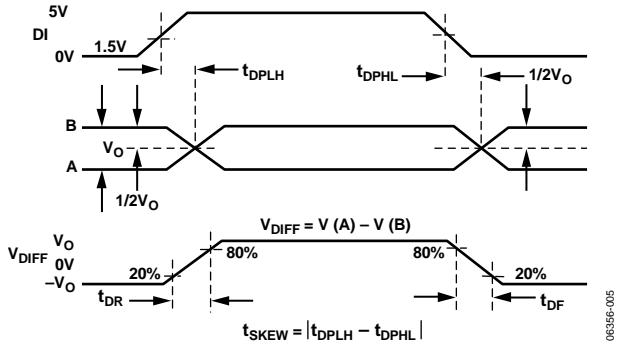

Figure 20. Driver Propagation Delays

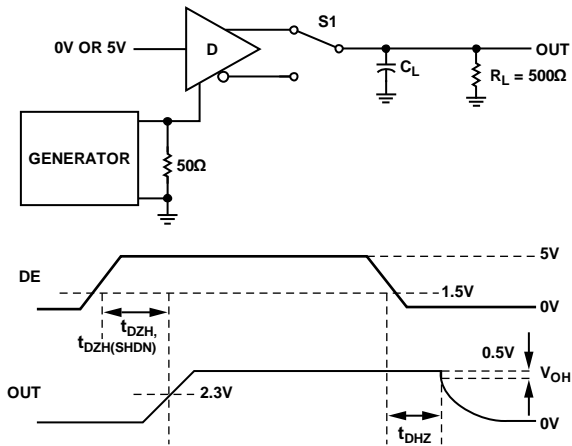

Figure 21. Driver Enable and Disable Times ( $t_{DZH}$ ,  $t_{DZH(SHDN)}$ ,  $t_{DHZ}$ ,  $t_{DHZ(SHDN)}$ )

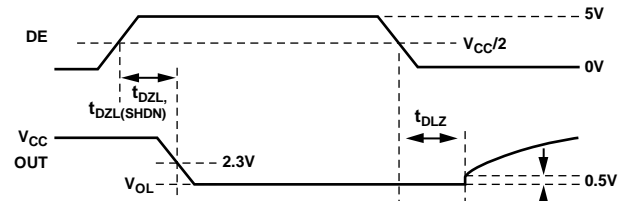
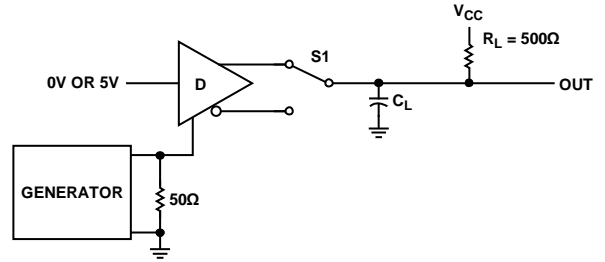

Figure 22. Driver Enable and Disable Times ( $t_{DZL}$ ,  $t_{DLZ}$ ,  $t_{DZL(SHDN)}$ )

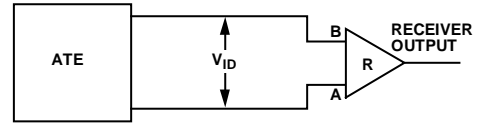
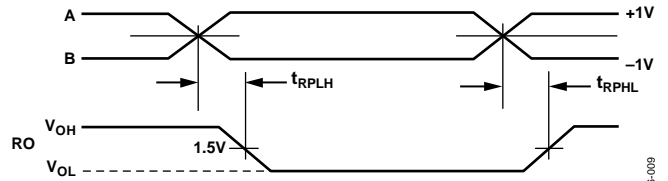

Figure 23. Receiver Propagation Delay Test Circuit



THE RISE TIME AND FALL TIME OF INPUT A AND INPUT B < 4 ns

Figure 24. Receiver Propagation Delays

# ADM485E/ADM487E/ADM1487E

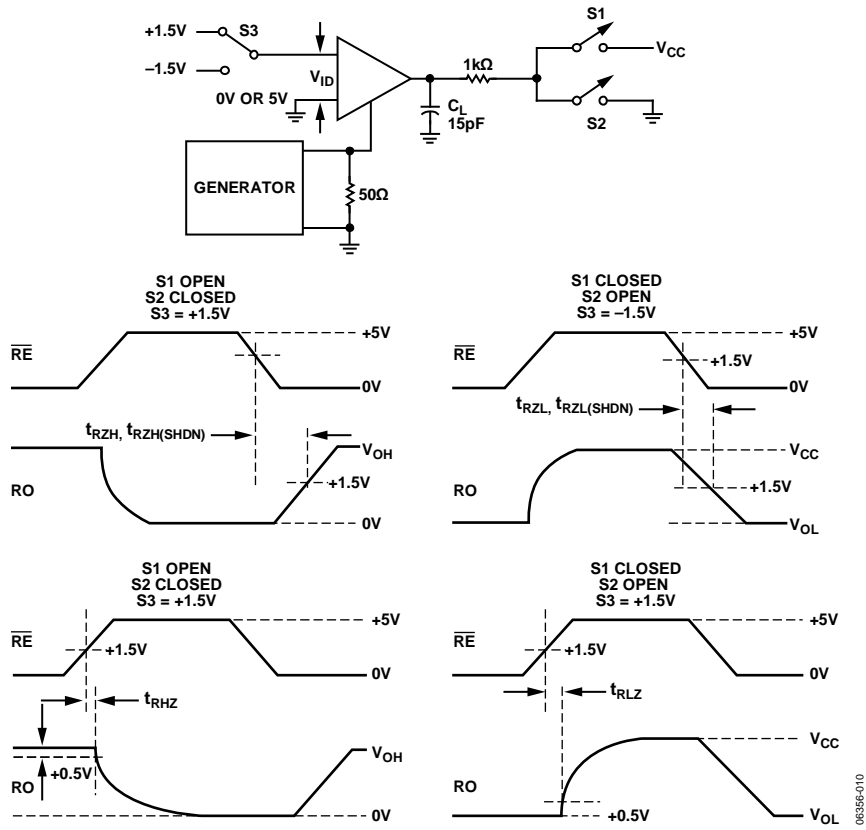

Figure 25. Receiver Enable and Disable Times

063366-010

## THEORY OF OPERATION

The ADM485E/ADM487E/ADM1487E are ruggedized RS-485 transceivers that operate from a single 5 V supply. They contain protection against high levels of electrostatic discharge and are ideally suited for operation in electrically harsh environments or where cables can be plugged or unplugged. These devices are intended for balanced data transmission and comply with TIA/EIA standards RS-485 and RS-422. They contain a differential line driver and a differential line receiver, and are suitable for half-duplex data transmission because the driver and receiver share the same differential pins.

The input impedance on the ADM485E is 12 kΩ, allowing up to 32 transceivers on the differential bus. The ADM487E/ADM1487E are 48 kΩ, allowing up to 128 transceivers on the differential bus.

## CIRCUIT DESCRIPTION

The ADM485E/ADM487E/ADM1487E are operated from a single 5 V ± 10% power supply. Excessive power dissipation caused by bus contention or output shorting is prevented by a thermal shutdown circuit. If, during fault conditions, a significant temperature increase is detected in the internal driver circuitry, this feature forces the driver output into a high impedance state.

The receiver contains a fail-safe feature that results in a logic high output state if the inputs are unconnected (floating).

A high level of robustness is achieved using internal protection circuitry, eliminating the need for external protection components, such as tranzorbs or surge suppressors.

Low electromagnetic emissions are achieved using slew rate-limited drivers, minimizing both conducted and radiated interference.

The ADM485E/ADM487E/ADM1487E can transmit at data rates up to 250 kbps.

A typical application for the ADM485E/ADM487E/ADM1487E is illustrated in Figure 26, which shows a half-duplex link where data can be transferred at rates up to 250 kbps. A terminating resistor is shown at both ends of the link. This termination is not critical because the slew rate is controlled by the ADM485E/ADM487E/ADM1487E and reflections are minimized.

The communications network can be extended to include multipoint connections, as shown in Figure 29. As many as 32 ADM485E transceivers or 128 ADM487E/ADM1487E transceivers can be connected to the bus.

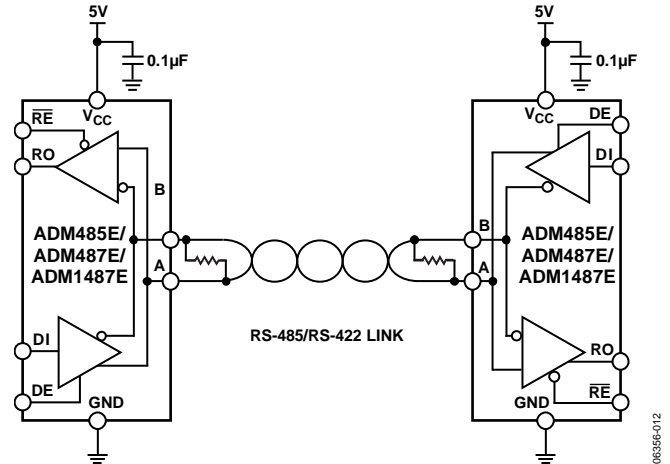

Figure 26. Typical Half-Duplex Link Application

Table 7 and Table 8 show the truth tables for transmitting and receiving.

Table 7. Transmitting Truth Table

Transmitting Inputs			Transmitting Outputs	
RE	DE	DI	B	A
X <sup>1</sup>	1	1	0	1
X <sup>1</sup>	1	0	1	0
0	0	X <sup>1</sup>	High-Z	High-Z
1	0	X <sup>1</sup>	High-Z	High-Z

<sup>1</sup>X = don't care.

Table 8. Receiving Truth Table

Receiving Inputs		Receiving Outputs	
RE	DE	A to B	RO
0	0	≥+0.2 V	1
0	0	≤-0.2 V	0
0	0	Inputs open circuit	1
1	0	X <sup>1</sup>	High-Z

<sup>1</sup>X = don't care.

## ESD Transient Protection Scheme

The ADM485E/ADM487E/ADM1487E use protective clamping structures on their inputs and outputs that clamp the voltage to a safe level and dissipate the energy present in ESD.

The protection structure achieves ESD protection up to ±15 kV human body model (HBM).

# ADM485E/ADM487E/ADM1487E

## ESD Testing

Two coupling methods are used for ESD testing: contact discharge and air-gap discharge. Contact discharge calls for a direct connection to the unit being tested; air-gap discharge uses a higher test voltage but does not make direct contact with the unit under test. With air discharge, the discharge gun is moved toward the unit under test, developing an arc across the air gap; thus, the term air discharge is used. This method is influenced by humidity, temperature, barometric pressure, distance, and rate of closure of the discharge gun. The contact-discharge method, though less realistic, is more repeatable and is gaining acceptance and preference over the air-gap method.

Although very little energy is contained within an ESD pulse, the extremely fast rise time, coupled with high voltages, can cause failures in unprotected semiconductors. Catastrophic destruction can occur immediately as a result of arcing or heating. Even if catastrophic failure does not occur immediately, the device can suffer from parametric degradation, which can result in degraded performance. The cumulative effects of continuous exposure can eventually lead to complete failure.

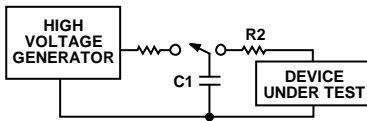

NOTES:  
1. THE ESD TEST METHOD USED IS THE HUMAN BODY MODEL ( $\pm 15\text{kV}$ ) WITH  $R2 = 1500\Omega$  AND  $C1 = 100\text{pF}$ .

Figure 27. ESD Generator

I/O lines are particularly vulnerable to ESD damage. Simply touching or plugging in an I/O cable can result in a static discharge that can damage or completely destroy the interface product connected to the I/O port. It is, therefore, extremely important to have high levels of ESD protection on the I/O lines.

The ESD discharge can induce latch-up in the device under test. Therefore, it is important that ESD testing on the I/O pins be carried out while device power is applied. This type of testing is more representative of a real-world I/O discharge where the equipment is operating normally when the discharge occurs.

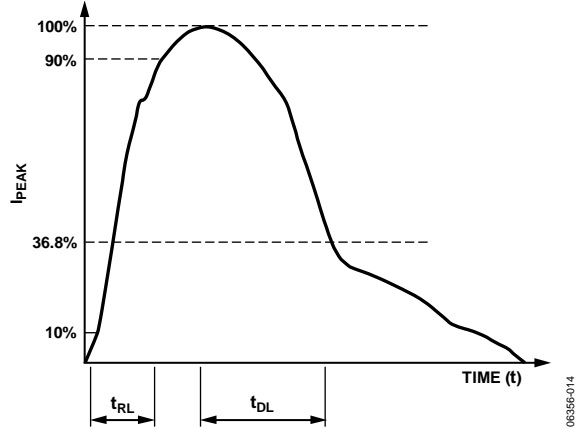

Figure 28. Human Body Model ESD Current Waveform

Table 9. ADM483E ESD Test Results

ESD Test Method	I/O Pins	Other Pins
Human body model (HBM)	$\pm 15\text{ kV}$	$\pm 3.5\text{ kV}$

## APPLICATIONS INFORMATION

### DIFFERENTIAL DATA TRANSMISSION

Differential data transmission is used to reliably transmit data at high rates over long distances and through noisy environments. Differential transmission nullifies the effects of ground shifts and noise signals that appear as common-mode voltages on the line. There are two main standards approved by TIA/EIA that specify the electrical characteristics of transceivers used in differential data transmission.

The RS-422 standard specifies data rates up to 10 MB and line lengths up to 4000 feet. A single driver can drive a transmission line with up to 10 receivers.

To cater to true multipoint communications, the RS-485 standard is defined. This standard meets or exceeds all the requirements of RS-422, but also allows for up to 32 drivers and 32 receivers to be connected to a single bus. An extended common-mode range of  $-7\text{ V}$  to  $+12\text{ V}$  is defined. The most significant difference between RS-422 and RS-485 is that the drivers can be disabled, thereby allowing as many as 32 drivers to be connected to a single line. Only one driver is enabled at a time, but the RS-485 standard contains additional specifications to guarantee device safety in the event of line contention.

### CABLE AND DATA RATE

The transmission line of choice for RS-485 communications is a twisted pair. A twisted pair cable can cancel common-mode noise and can also cause cancellation of the magnetic fields generated by the current flowing through each wire, thereby reducing the effective inductance of the pair.

A typical application showing a multipoint transmission network is illustrated in Figure 29. An RS-485 transmission line can have as many as 32 transceivers on the bus. Only one driver can transmit at a particular time, but multiple receivers can be enabled simultaneously.

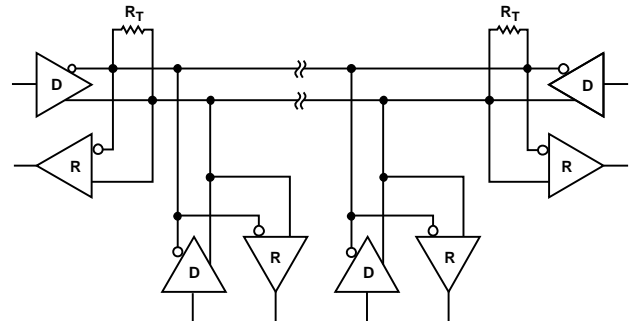
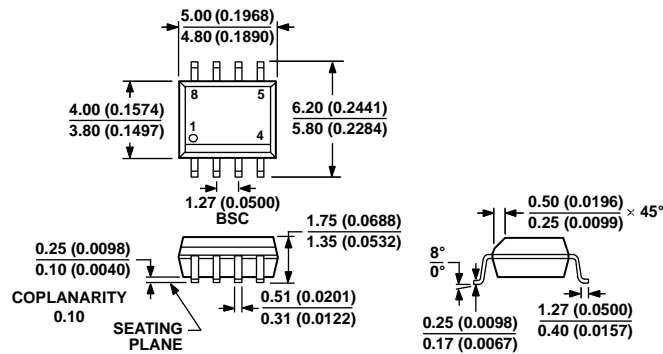

Figure 29. Typical RS-485 Network

06356-015

# ADM485E/ADM487E/ADM1487E

## OUTLINE DIMENSIONS



COMPLIANT TO JEDEC STANDARDS MS-012-AA  
 CONTROLLING DIMENSIONS ARE IN MILLIMETERS; INCH DIMENSIONS  
 (IN PARENTHESES) ARE ROUNDED-OFF MILLIMETER EQUIVALENTS FOR  
 REFERENCE ONLY AND ARE NOT APPROPRIATE FOR USE IN DESIGN.

Figure 30. 8-Lead Standard Small Outline Package [SOIC\_N]  
 Narrow Body  
 (R-8)

Dimensions shown in millimeters and (inches)

## ORDERING GUIDE

Model <sup>1, 2</sup>	Temperature Range	Package Description	Package Option
ADM485EARZ	-40°C to +85°C	8-Lead Standard Small Outline Package (SOIC_N)	R-8
ADM485EARZ-REEL7	-40°C to +85°C	8-Lead Standard Small Outline Package (SOIC_N)	R-8
ADM487EARZ	-40°C to +85°C	8-Lead Standard Small Outline Package (SOIC_N)	R-8
ADM487EARZ-REEL7	-40°C to +85°C	8-Lead Standard Small Outline Package (SOIC_N)	R-8
ADM487EARZ	-40°C to +85°C	8-Lead Standard Small Outline Package (SOIC_N)	R-8
ADM487EARZ-REEL7	-40°C to +85°C	8-Lead Standard Small Outline Package (SOIC_N)	R-8
ADM1487EARZ	-40°C to +85°C	8-Lead Standard Small Outline Package (SOIC_N)	R-8
ADM1487EARZ-REEL7	-40°C to +85°C	8-Lead Standard Small Outline Package (SOIC_N)	R-8

<sup>1</sup> Z = RoHS Compliant Part.

<sup>2</sup> W = Qualified for Automotive Applications.

## AUTOMOTIVE PRODUCTS

The ADM487EW models are available with controlled manufacturing to support the quality and reliability requirements of automotive applications. Note that these automotive models may have specifications that differ from the commercial models; therefore, designers should review the Specifications section of this data sheet carefully. Only the automotive grade products shown are available for use in automotive applications. Contact your local Analog Devices account representative for specific product ordering information and to obtain the specific Automotive Reliability reports for these models.